

### ■ Features

- Constant voltage and current output
- Universal AC input 100~305VAC
- Built-in active PFC function
- High efficiency
- Output protections: Short circuit/Over voltage/Over load
- Fixed derating-cutoff type temperature protection
- Digital, analog or DALI control dimming function
- Suitable for inside of the outdoor LED luminaires
- IP65 with Vo/Io adjusting screws, IP67 without Vo/Io adjusting screws
- Compliance to worldwide safety regulations for lighting
- Suitable for dry/damp/wet locations
- Eight years warranty



IP65/67



### ■ General functions

Output Power	400W	Input Frequency	50/60Hz
Input Voltage Range	100~305Vac	Operating Temperature	-40 ℃ ~+60 ℃
Storage Temperature	-45 ℃ ~+85 ℃	Safety & EMC	UL8750, IEC61347, EN55015
Turn-on Delay Time	3.0S max.	Inrush Current	40A at 230Vac, Cold start
Over Temp Protection	Fixed derating-cutoff type temperature protection	Waterproof	IP65/IP67

### ■ Detailed Specification

TABLE 1:

Model		DH400-060S667X-YY	DH400-048S833X-YY	DH400-024S1667X-YY	DH400-012S2500X-YY	
Output	DC Voltage	60Vdc	48Vdc	24dc	12Vdc	
	Constant Current Operation Voltage <small>note.5</small>	36~60Vdc	28.8~48Vdc	14.4~24Vdc	7~12Vdc	
	Rated DC Current	6.67A	8.33A	16.67A	25A	
	Current Range	0~6.67A	0~8.33A	0~16.67A	0~25A	
	Dimming Current Range	10~100% rated output current (≥50% rated output voltage)				
	Ripple and Noise	500mVp-p	350mVp-p	350mVp-p	350mVp-p	
	Voltage ADJ. Range <small>note.3</small>	54~63Vdc	43~50Vdc	22~25Vdc	11~13Vdc	
	Current ADJ. Range <small>note.3</small>	3.34~6.67A	4.17~8.33A	8.34~16.67A	12.5~25A	
	Voltage Tolerance	±1%	±1%	±1%	±1%	
	Voltage Line Regulation	±0.5%	±0.5%	±0.5%	±0.5%	
	Voltage Load Regulation	±0.5%	±0.5%	±0.5%	±0.5%	
Input	Efficiency	95%	94.5%	94%	92.5%	
	Power Factor	0.97/230Vac	0.97/230Vac	0.97/230Vac	0.97/230Vac	
	AC Current	4.6A/100Vac, 2.10A/230Vac				
	Leakage Current	<0.75mA/230Vac; <0.5mA/120Vac				
Output Protection	Over Current	Constant current limiting				
	Short Circuit	Non-dimmer type: recover automatically at hiccup; Dimmer type: Short-circuit power ≤10W.				
	Over Voltage	Shut down at 140% Vo and latch off o/p voltage, re-power on to recover				
Environmental	Operating Humidity	20~95% RH, non-condensing				
	Storage Humidity	10~95% RH				
	Temperature Coefficient	±0.03%/℃ (0~50℃)				
	Vibration	10~300Hz, 1G, Period for 60min, each along X、Y、Z axes.				
Safety & EMC	Withstand Voltage	I/P-OP: 3.75kVac; IP-FG: 1.56kVac/2.00kVac (remove discharge tube); O/P-FG: 2.00kVac				
	Isolation Resistance	IP-OP, IP-FG, O/P-FG: 100M Ohms/500Vdc/25℃/70% RH				
	EMC Interference	Compliance to EN55015, EN55022 (CISPR22) Class B				
	EMC Emission	Compliance to EN61000-3-2 Class C (≥50%load); EN61000-3-3				
	EMC Immunity	Compliance to EN61000-4-2, 3, 4, 5, 6, 8, 11; ENV50204, EN61547, EN55024				
Others	Authentication	UL/TUV/FCC/CE/RoHS/CQC				
	MTBF	147k Hrs at full load and 30℃ ambient conditions per MIL-HDBK-217F				
	Input Over-voltage	Can survive input over-voltage stress of 320Vac for 48 hours				
	Dimensions (mm)	290×100×40				
	Max. Case Temp.	Tc max=80℃				
	Net Weight	2.43Kg/pcs				
Note	1. All parameters NOT specially mentioned are measured at 230Vac input, rated load and 25℃ of ambient temperature.					
	2. Ripple & noise are measured: at 20MHz of bandwidth by using a 12" twisted pair-wire terminated with a 0.1μf & 47μf parallel capacitor.					
	3. Output voltage and current can be adjusted by internal potentiometer ("A" type only).					
	4. Tolerance: includes set up tolerance, voltage line regulation and voltage load regulation.					
	5. Constant current operation region is within 60% ~100% rated output voltage. This is the suitable operation region for LED related applications, but please reconfirm special electrical requirements for some specific system design.					
	6. Derating may be needed under low input voltages. Please check the Static Characteristics for more details.					
	7. Safety and EMC design refer to EN60598-1, subject 8750 (UL), CNS15233, GB7000.1, FCC part18.					
	8. Length of set up time is measured at cold first start. Turning ON/OFF the power supply may lead to increase of the set up time.					
	9. The power supply is considered as a component that will be operated in combination with final equipment. Since EMC performance will be affected by the complete installation, the final equipment manufacturers must re-qualify EMC Directive on the complete installation again.					

### Part number code

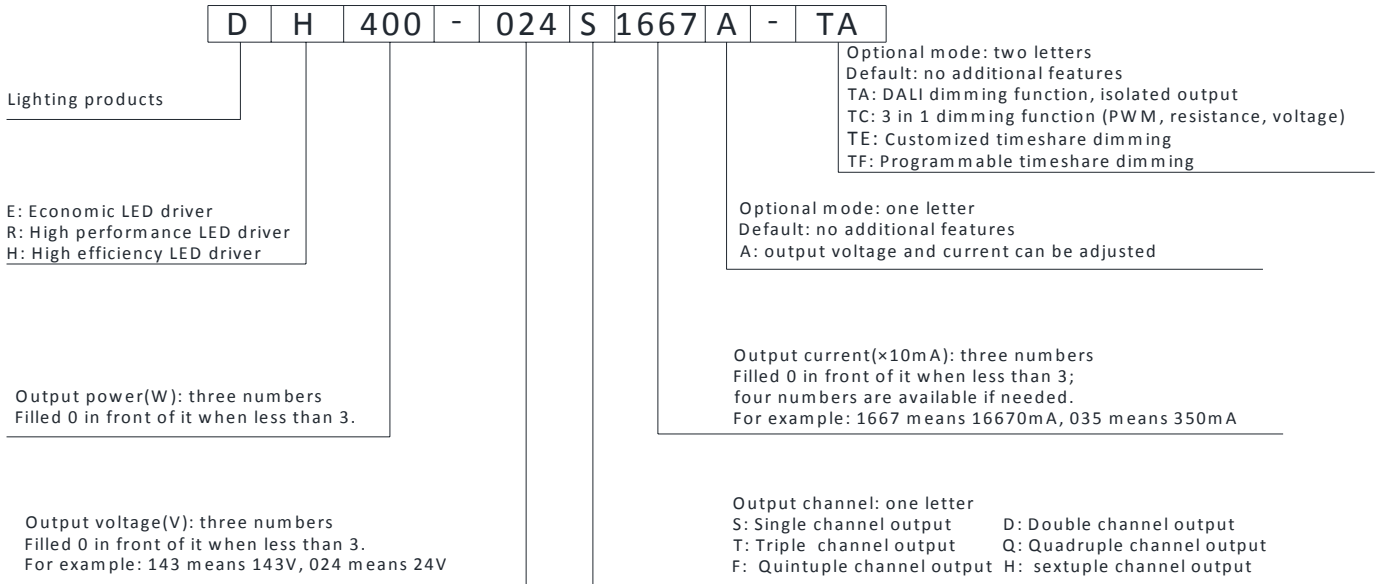

For example: DH400-024S1667A-TA means: high efficiency LED driver; output power 400W; output voltage 24Vdc; output current 16670mA; single output; output voltage and current can be adjusted; with DALI dimming function and isolated output.

### wiring diagram

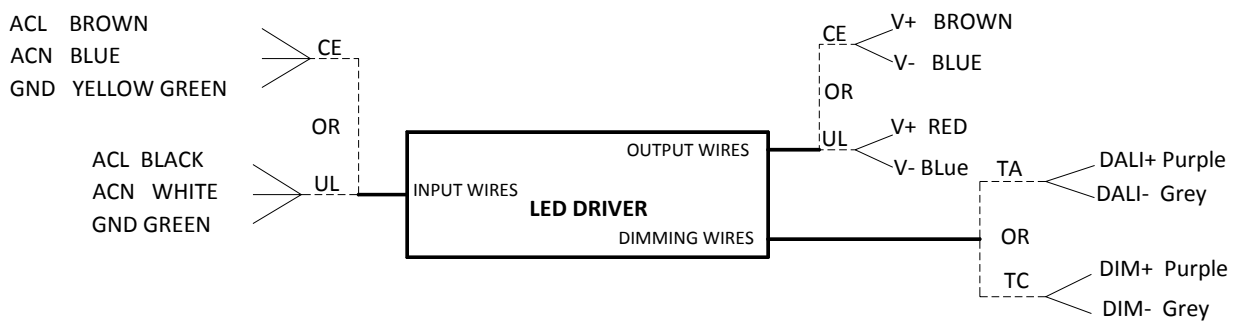

#### ■ Derating Curve

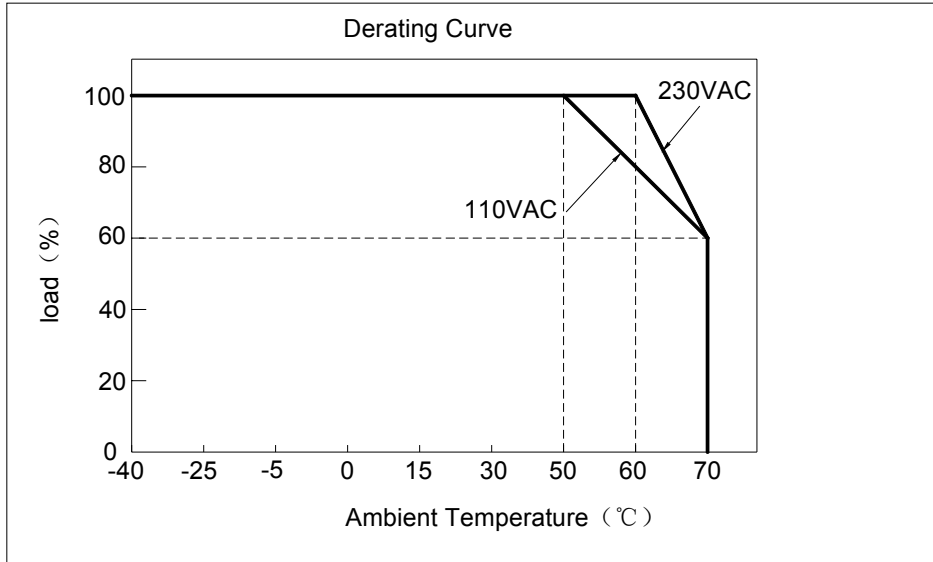

#### ■ Static Characteristics

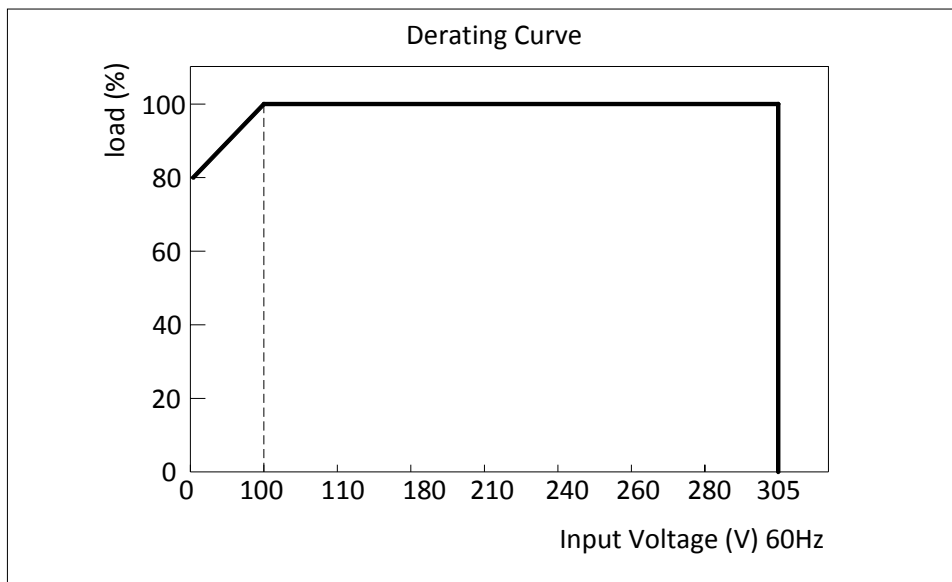

### Power Factor Characteristic (DH400-024S1667)

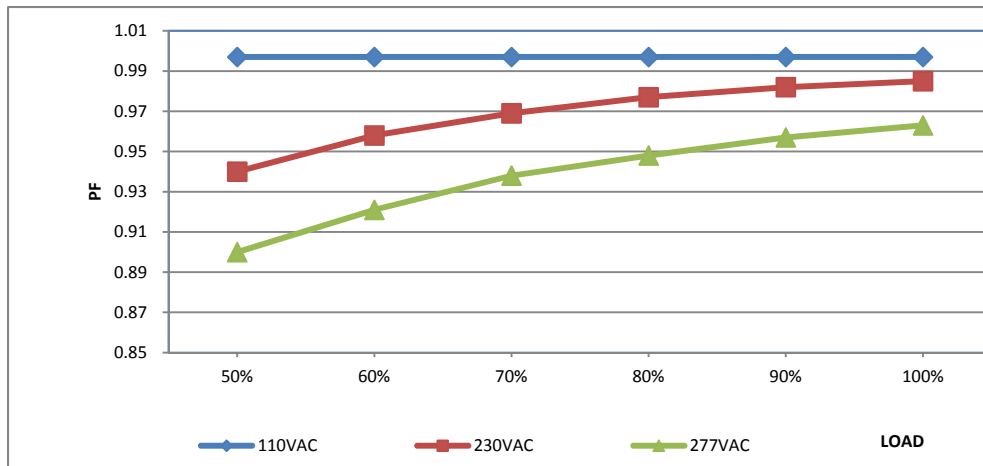

### EFFICIENCY vs LOAD (DH400-024S1667)

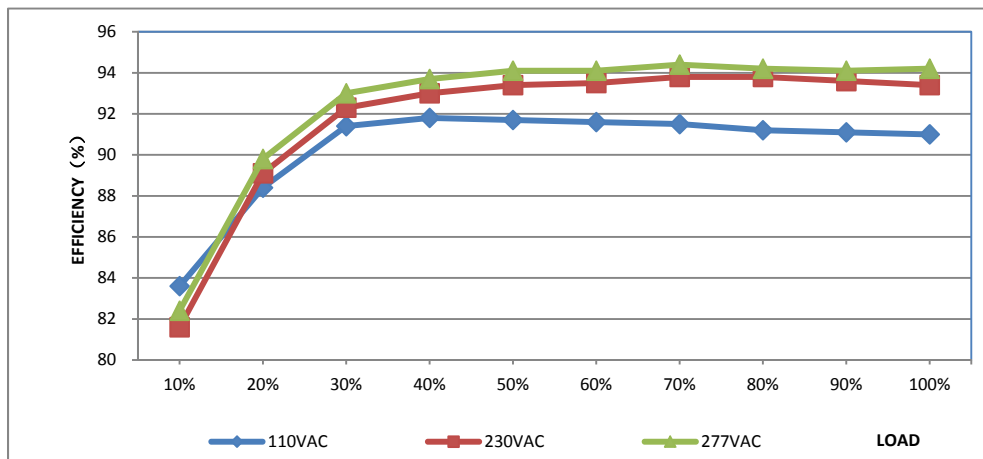

### Typical LED power supply I-V curve

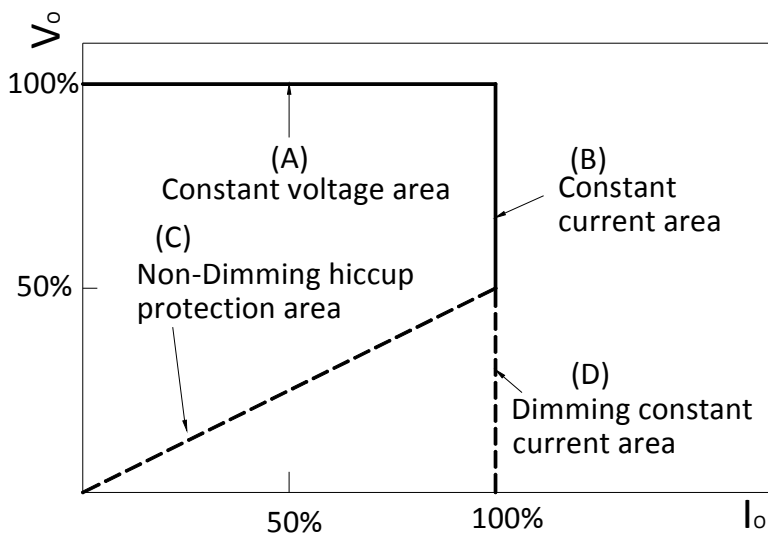

### Mechanical Outline

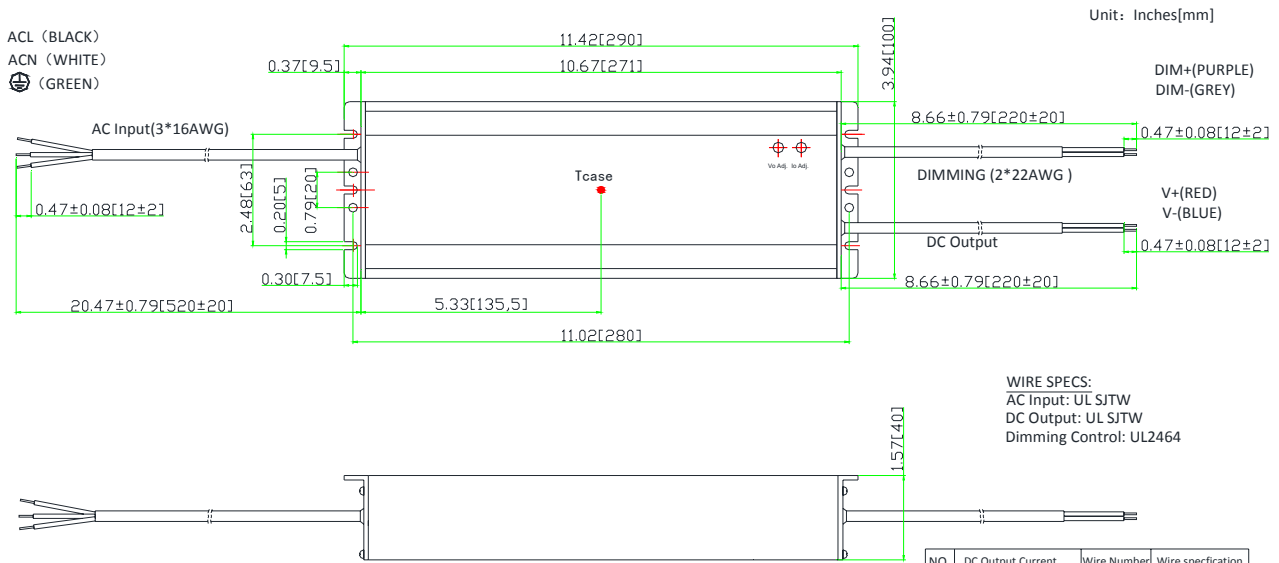

- ※ Tcase: Max. Case Temperature.
- ※ Power's internal temperature is 10°C warmer than case temperature.
- ※ No dimming control wire if without dimming function.
- ※ Please DO NOT connect "DIM -" to "V -" (load)

### "A" option

- a. Output voltage and current can be adjusted by internal potentiometer.
- b. IP65.
- c. These products shall be enclosed in the end product, when the unit provided with voltage and current adjustable holes.

### "-TA" option: DALI dimming

- a. DALI Testing Software: Please refer to [www.brightway-tech.com](http://www.brightway-tech.com) for downloading.
- b. Percentage of rated current: 10%~100%.
- c. "TA" version LED driver shall work with a DALI Master and DALI Master control software.



#### ■“-TC” option: 0-10V, resistance & PWM dimming

a. Reference resistance value for output current adjustment (Typical)

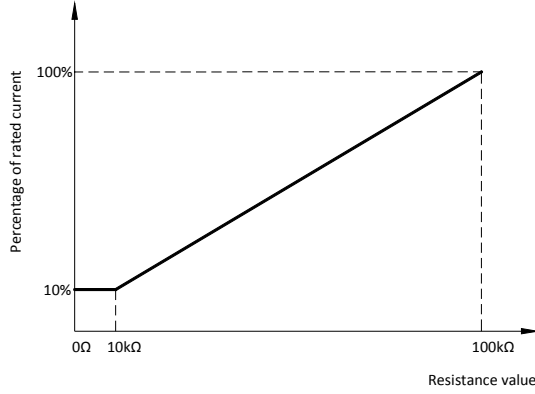

b. 0-10V dimming function for output current adjustment (Typical)

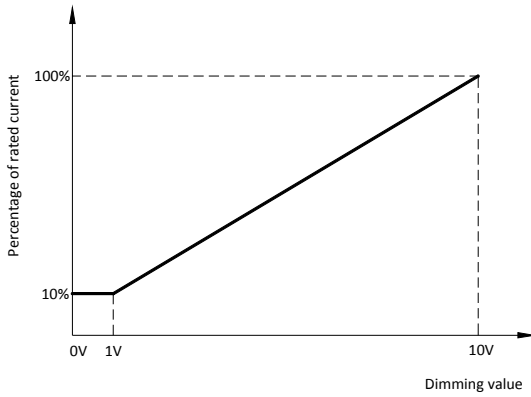

c. 10V PWM signal for output current adjustment (Typical): Frequency range: 200Hz~1.5KHz

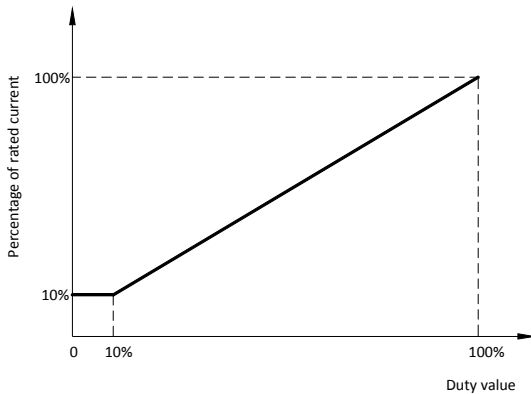

Dimming control details:

Parameters		Minimum	Typical	Maximum
Dimming Type	Resistance	0kΩ	0-100kΩ	∞
	Voltage	-2V	0-10V	15V
	PWM(10%~100% f=200Hz~1.5KHz)	-2V	0-10V	15V
Dimming Current		-0.5mA	-	0.5mA

### ■ "-TE" option: Customized timeshare dimming.

- Different output current (10% - 100% rate output current) can be set for different time periods.
- Maximum 4 sections is available. The minimum length is 0 to maximum 12 hours for each section.
- The parameter can't be changed after shipping.

### ■ "-TF" option: Programmable timeshare dimming.

- Output current is programmable with the range of 10%~100% of rated output current.
- Maximum 4 sections timeshare dimming is available. The minimum length is 0 to maximum 12 hours for each section.

For example:

The first section: the time period is 0~1h, the output current is 40% of rated output current.

The second section: the time period is 1h~4h, the output current is 100% of rated output current.

The third section: the time period is 4h~8h, the output current is 40% of rated output current.

The fourth section: the time period is 8h~12h, output current is 60% of rated output current.

- The parameters are set by a programmer.
- The data interface is waterproof.

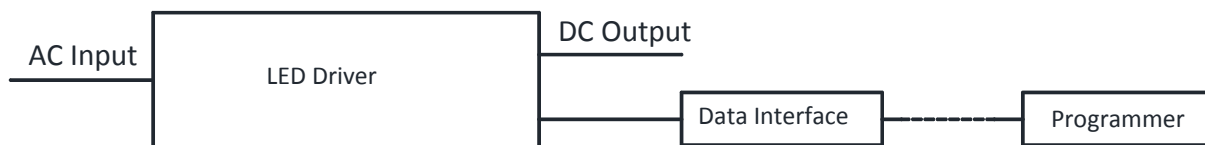

### ■ Input and output Dielectric strength

Isolation	Input Wires	Output Wires	Isolated Dimming Control Wires	Chassis
Input Wires	NA	3750	2000	1560/2000(remove discharge tube)
Output Wires	3750	NA	2000	2000
Isolated Dimming Control Wires	2000	2000	NA	2000
Chassis	1560/2000(remove discharge tube)	2000	2000	NA



## ■ Fixed derating-cutoff type temperature protection

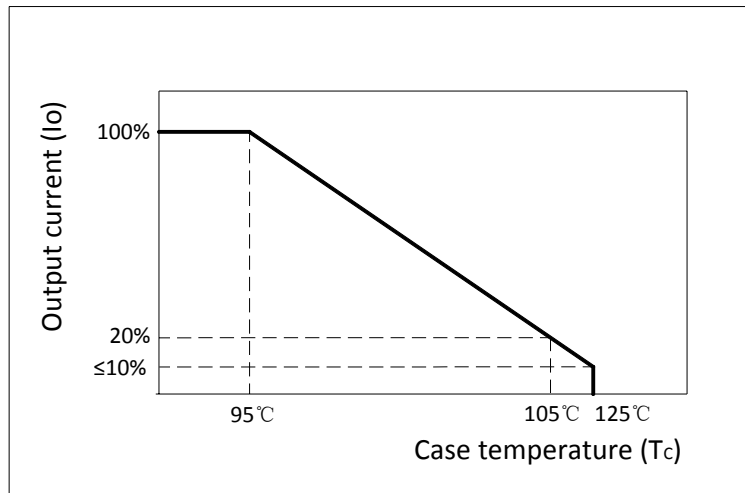

This datasheet is for reference only. Brightway reserves all rights for final explanation of the technical materials.